

Gabbioneta Pumps™
Vertical Multistage Pumps
VD-VLD Range

General information

The VD, VLD range heavy duty process pumps, available in double-casing or wet pit configurations, are vertical multistage, double volute/diffuser type pumps designed for full compliance with latest edition of API 610 Standard.

A wide range of sizes and material combinations complete the variety of the offered products.

Main design features:

- Geometry of pump components optimised through hydraulic, structural, thermal and dynamic F.E.M. analysis to guarantee high product reliability
- Closed type impeller with front and rear wear rings as well as balancing holes, to minimise the axial thrust
- Double suction 1st stage impeller to meet low NPSH requirements
- Deep stuffing boxes, designed in accordance to API 682 Standard, suitable to accept any type of mechanical or packing seal
- Labyrinths and deflectors at both bearing housing covers to maximise protection against dirt
- Number of stages rangeable from 1 to 5
- Pump shaft in one or two pieces, fully machined to respect the more restrictive run-out API limits
- Air fan or water cooling system provided on bearing bracket
- Rotor axial thrust supported by a duplex oil lubricated ball angular contact type bearing as a standard
- Renewable bushings are provided at all interstage casing and column

Options

The following pump designs can be provided:

- Additional rigid coupling to facilitate mechanical seal maintenance activities.
- Enclosed lineshaft construction to protect shaft
- Inside drain line
- Axial thrust tilting pad bearings for ultra high thrust operating condition
- Anti reverse rotation device
- Special bearing isolators at both bearing housing ends
- Oil mist lubrication (pure or purge)
- Temperature and/or vibration detection and monitoring equipment

Main pumps applications refer to heavy duties on

- Oil & Gas
- Sump service
- Water
- Firefighting
- Hydrocarbon and petrochemical processing
- General purpose

Operating data

Capacity

up to 2500 m³/h (11000 USgpm)

Head

up to 500 m (1600 feet)

Temperature

from -150°C (-240°F) to 400°C (750°F)

Design working pressure

up to 60 barg (900 psig)

Rotational speed

up to 2000 rpm



VD Overall Dimensions

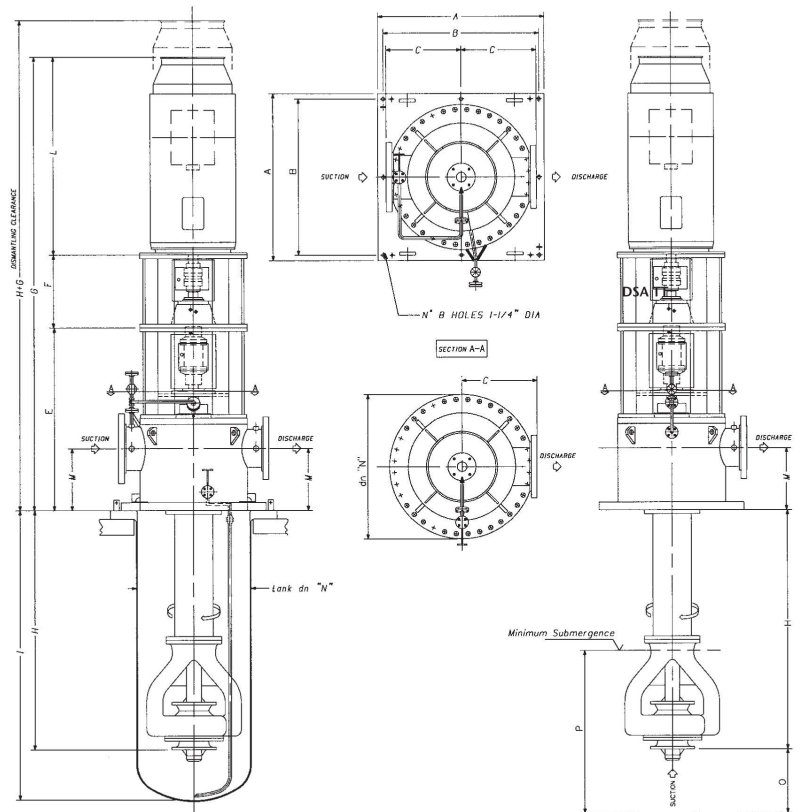

Pump Type	Nozzle Size		A	B	C	D	E	F		H	I	M	N	O	P
	Suct.	Disch.						Min	Max						
VD 500/350	16"	14"	1550	1450	700	1 - 1/4"	1705	625	749	1273	1745	580	42"	500	1500
VD 600/350	16"	14"	1550	1450	700	1 - 1/4"	1705	625	749	1305	1600	600	44"	500	1500

General notes

1. All dimensions are in mm. Do not use for construction unless certified.
2. Dimensions G and I vary with driver selection.

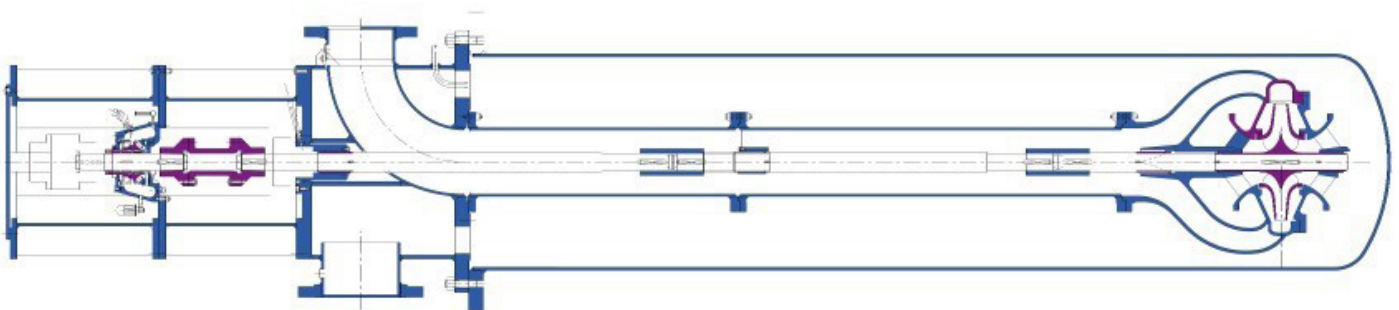

VLD Overall dimensions

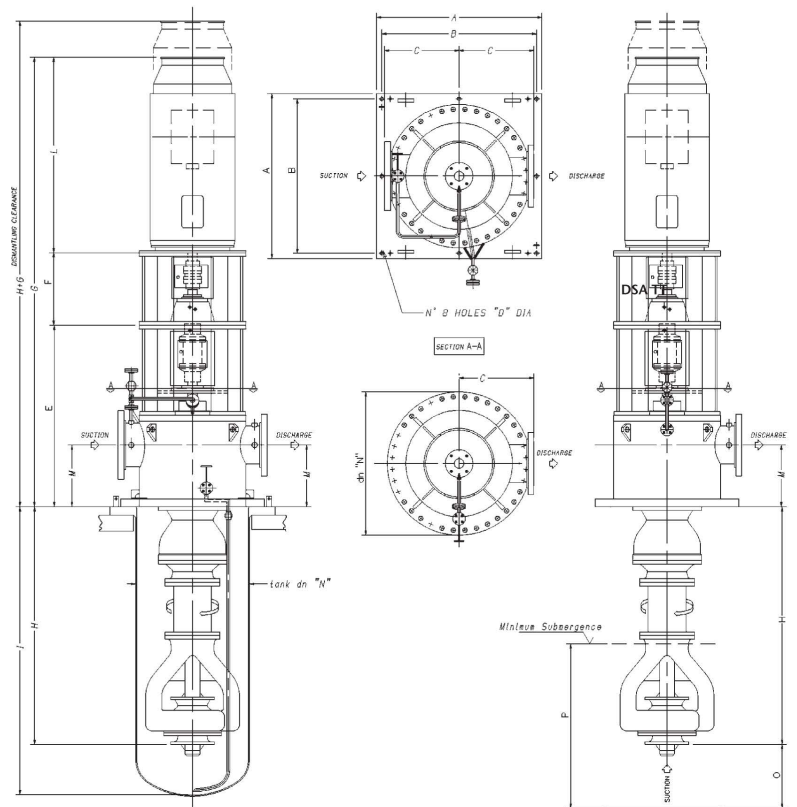

Pump Type	Nozzle Size		Stages Min	A	B	C	D	E	F		H Min	I Min	M	N	O	P
	Suct.	Disch.							Min	Max						
VD 500/350	16"	14"	2	1550	1450	700	1 - 1/4"	1705	625	749	1273	1745	580	42"	500	1500
VD 600/350	16"	14"	2	1550	1450	700	1 - 1/4"	1705	625	749	1305	1600	600	44"	500	1500

General notes

1. All dimensions are in mm. Do not use for construction unless certified.
2. Dimensions G and I vary with driver selection.

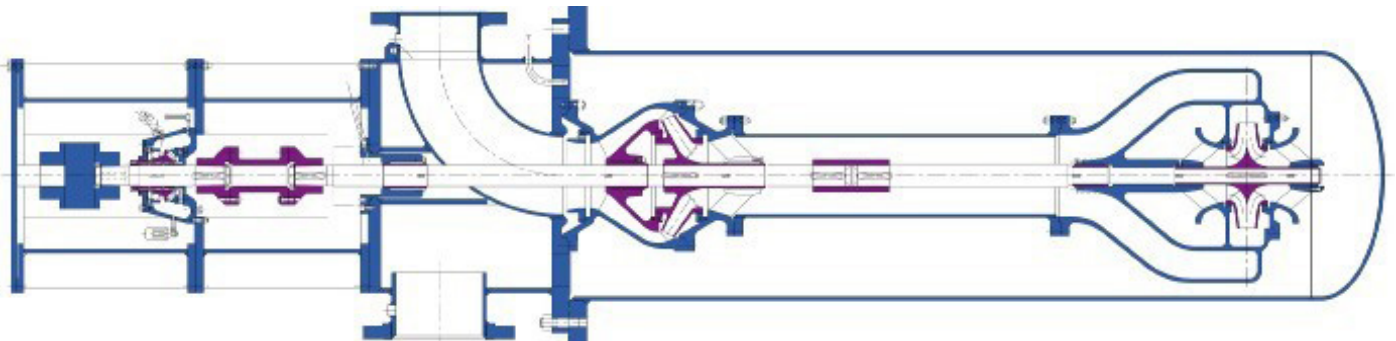

Coverage Chart

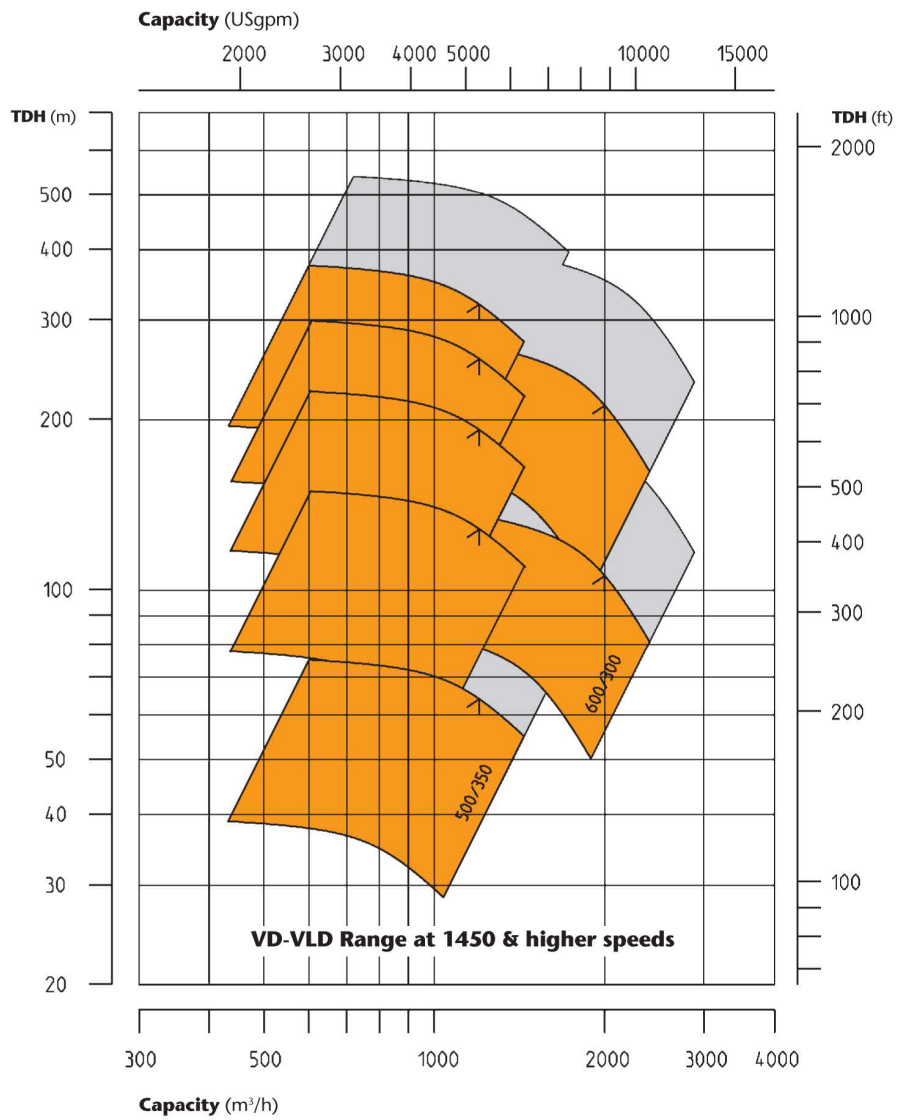

Pump identification

Pump type VLD 600 / 350

Nominal impeller diameter (mm) _____

Nominal discharge nozzle diameter (mm) _____

A century of experience

Since the foundation of the company in 1897, Gabbioneta pumps™ has been engaged in design and manufacture of high quality centrifugal pumps.

The products and the markets served progressively changed from water to chemical industry and finally, in the last thirty years, to API 610 heavy duty pumps for refinery and petrochemical industries.

Product development is based on a thorough interchange of marketing and operating experience within the company and in close cooperation with project and plant engineers.

Manufacturing is carried out in a factory equipped with several modern CNC machines and machine tools. Special note has to be given to the machining centers where pump casings can be machined completely with only two settings.

In-house facilities are designed to meet the performance and NPSH testing requirements of all pumps manufactured in the company in full compliance with API 610 Standards.

A quality assurance system certified in accordance with ISO 9001 ensures Gabbioneta pumps™ are of the highest quality.





Trillium Pumps Italy S.r.l.
Società Unipersonale

Gaetana Agnesi 1, 20834 Nova Milanese (MB), Italy
T: +39 0362 17331; Fax: +39 0362 1733550; E: gabbioneta.sales@trilliumflow.com

www.trilliumflow.com Certified: ISO 9001:2015, ISO 14001:2015, OHSAS 18001:2007